



Picture shows BoxPC-NUCV with custom color option and various other options

## Manufacturer

E.E.P.D. Electronic Equipment Produktion & Distribution GmbH  
Gewerbering 3  
85258 Weichs

Phone.: +49 8136 2282 – 0  
Fax.: +49 8136 2282 – 109  
Web: <https://www.eepd.de>

## General Notes

This user manual is for your information only.

The information contained herein has been checked carefully and is believed to be reliable. However, E.E.P.D. GmbH gives no guarantee or warranty concerning the accuracy of spoken information and shall not be responsible for any loss or damage of any nature resulting from the usage of or from reliance upon it.

We are thankful for all suggestions or improvements at any time.

E.E.P.D. GmbH reserves the right to make changes in the products or specifications, or both, at any time without notice.

## Copyright Notice

Copyright© 2019|2020 E.E.P.D. GmbH. ALL RIGHTS RESERVED!

E.E.P.D. GmbH copyrights this document. You may not reproduce, transmit, transcribe, store in a retrieval system, or translate into any language or computer language, in any form or by any means, or otherwise, any part of this publication without the express written permission of E.E.P.D. GmbH.

## Trademark Acknowledgement

E.E.P.D.® and EMTRUST® are registered trademarks of E.E.P.D. GmbH. All rights reserved. All other mentioned trademarks are registered trademarks of their owners.

03/2021 Version 3.1

E.E.P.D. GmbH | Gewerbering 3 | 85258 Weichs

Copyright © 2020|2021 by E.E.P.D. GmbH. All right reserved. |  
Rev.3.1

## Disclaimer

This document is provided for the general information of the customer. It describes the general functionality of the system and is not considered as assured characteristics. The written declarations in this document are not constituent part of any contract.

E.E.P.D. GmbH reserves the right to modify the information contained in this document as necessary and the customer should ensure that he has the most recent revision of this document.

E.E.P.D. GmbH makes no warranty for the use of its products and bears no responsibility for any errors, which may appear in this document. The customer should be on notice that the field of personal computers is the subject of many patents held by different parties. Customers must ensure that they take appropriate action so that their use of the products does not infringe upon any patents. It is the policy of E.E.P.D. GmbH to respect the valid patent rights of third parties and not to infringe upon or assist others to infringe upon such rights.

E.E.P.D. GmbH assumes no responsibility for circuits, descriptions and tables within this document as far as patents or other rights of third parties are concerned.

## Life Support Applications

E.E.P.D. GmbH products are not intended for being used as critical components in life support appliances, devices or systems in which the failing of an E.E.P.D. GmbH product could be expected to result in personal injury.

E.E.P.D. GmbH | Gewerbering 3 | 85258 Weichs

Copyright © 2020|2021 by E.E.P.D. GmbH. All right reserved. |  
Rev.3.1

## FCC and CE Disclaimer

E.E.P.D. GmbH gives no warranty at all that their products will meet the FCC and CE standards when used in combination with other third party products or when used in any other way than specified.

## Limited Warranty

This product will be free from defects in workmanship and material under normal and proper use for the period of time defined in our General Terms of Business, effective the date of the original shipment from E.E.P.D. GmbH.

In the event of a warranty claim for defects, which appear within the warranty period, customer shall deliver the product along with proof of purchase to the original place of purchase, shipping prepaid. Repair, replacement or refund of the purchase price of the defective product will be at the sole option of the manufacturer. All transportation risks and costs in connection with warranty service are the responsibility of the customer.

THIS WARRANTY IS IN LIEU OF ALL OTHER WARRANTIES, EXPRESS OR IMPLIED, INCLUDING WITHOUT LIMITATION, IMPLIED WARRANTIES OF MERCHANTABILITY AND FITNESS FOR A PARTICULAR PURPOSE, TO ANY CUSTOMER, CONSUMER, END USER, PURCHASER, OR OTHERWISE. IN NO EVENT SHALL MANUFACTURER BE LIABLE FOR LOSS OF PROFITS, INDIRECT, SPECIAL, INCIDENTAL, OR CONSEQUENTIAL DAMAGES ARISING OUT OF ANY BREACH OF CONTRACT OR WARRANTY, NEGLIGENCE, STRICT LIABILITY OR OTHERWISE.

The remedies for defects in this product are limited to those set forth above. If this limitation of remedies is held by any court to be void or unenforceable, or if no warranty is made, manufacturers liability shall in no event exceed the purchase price of the product giving rise to the claim, regardless of whether

such claim is brought in breach of contract or warranty, negligence, strict liability or otherwise.

## Reshipment

If you return the BoxPC system to E.E.P.D. GmbH please remove all connections and peripheral equipment.

Protect the unit with a suitable packaging, preferably use the original packaging.

## Packaging

The BoxPC system is in a protective package to avoid damage during transport.

This protective package should be recycled in an environmentally friendly way after use.

## Disposal of Device



At the end of the lifetime please dispose and/or recycle the components of the device accordingly.

## Customer Support

Please contact:

<https://www.eepd.de/support/>

## Technical Support

For technical information about hardware and software please contact:

[sales@eepd.de](mailto:sales@eepd.de).

## Table of Contents

<b>General Notes</b> .....	<b>1</b>	Connection Overview .....	15
<b>Symbols</b> .....	<b>5</b>	MicroSIM Card .....	16
<b>Safety Instructions</b> .....	<b>6</b>	MicroSD Card .....	16
Safety of People .....	6	Power Button   Power and HDD/SSD LED .....	17
Device Safety .....	6	<b>Pin Assignment</b> .....	<b>18</b>
Cooling System .....	6	MiniDisplay Ports .....	18
<b>System Information</b> .....	<b>7</b>	Dual-USB 3.0 .....	18
Required Tools .....	7	Gigabit Ethernet Dual-Port .....	19
External Notice .....	7	Power Connector (DC) .....	19
Software .....	7	RS232 (optional) .....	20
Options .....	7	RS232 / RS485 (UART / optional) .....	20
Accessories .....	8	Rear USB 3.0 Port .....	21
System Features and Intended Use .....	8	MicroSD Slot .....	21
<b>Scope of Delivery</b> .....	<b>9</b>	<b>Commissioning</b> .....	<b>22</b>
Type Label .....	9	Switching on the device / Operation .....	22
<b>System Mounting</b> .....	<b>9</b>	<b>Revision History</b> .....	<b>23</b>
System Dimensions .....	10	<b>Index of Figures</b> .....	<b>24</b>
DIN Rail Mounting (optional) .....	12	<b>Index of Tables</b> .....	<b>24</b>
<b>Technical Data</b> .....	<b>14</b>	<b>List of Abbreviations</b> .....	<b>25</b>
<b>Interfaces</b> .....	<b>15</b>		

## Symbols



The red danger sign warns you if incorrect operation puts your life or health at great risk. Both the components and the peripherals could be destroyed.

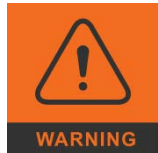

The orange warning sign warns you that an incorrect or missing operation could seriously endanger your health or destroy the used components.



The yellow caution sign indicates that an incorrect or missing action could damage the components.



The yellow ESD symbol indicates that electrostatic sensitive components could be destroyed. Unpack shielded components only with ESD protection such as an ESD wristband or on an ESD protected area.



The information sign gives you further information and advice for optimal use of this product. For example, it draws your attention to necessary or optional accessories.

## Safety Instructions

### Safety of People



The product generates considerable heat. The housing transports this heat to the environment and thus becomes hot. Take care if you touch the housing as this may cause burns!

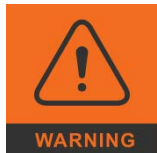

Please follow all safety instructions at the installation site. Make sure that no or only necessary cables are connected to the BoxPC during installation.



If access to the BoxPC interfaces is not available after installation, all necessary connections must be made before.

### Device Safety



The BoxPC operates exclusively within the specified DC voltage range. Repair work should only be made by an authorized and certified specialty retailer or by the manufacturer's customer service. Do not open the device to avoid damage.

Modifications that have not been approved by the manufacturer void the warranty. Dust, dirt, moisture, and extreme temperatures may significantly impair proper operation.

### Cooling System



The BoxPC consists of a compact, robust metal housing with ventilation holes. It is equipped with an automated fan. To ensure sufficient heat dissipation, never cover the ventilation holes of the case. Do not place any objects onto the device.

## System Information

### Required Tools

For the installation of the BoxPC system the following standard tools are recommended:

- Rail mounting: Torx screwdriver T10
- Cable connection: Slot screwdriver

Other required tools are depending on the installation place and method.

### External Notice

All external documentation to install the BoxPC system should be obeyed.

### Software

Supported operating systems are Microsoft® Windows® 10, Microsoft® Windows® 10 IoT Enterprise und Linux Ubuntu 18.04 LTS.

## Options

Options	Description
Memory*	V1000 processors: Max. 32 GB dual-channel DDR4 SODIMM up to 3200 MT/s R1000 processors: Max. 32GB dual-channel DDR4 SODIMM up to 2400 MT/s R1000 R1102G processor: Max. 16GB single-channel DDR4 SODIMM up to 2400 MT/s
SSD*	64 GB – 512 GB
LTE/modem module*#	M.2 LTE card with three SMA connectors
WLAN/BT module kit*#	M.2 WLAN/BT card with 2 SMA-connectors
Operating System*	Windows® 10, Windows® 10 IoT Enterprise, Linux Ubuntu 18.04 LTS
RS232 cable*	9-pin D-SUB plug
RS485 cable*	9-pin D-SUB plug
Power switch*	Power switch with LED
Sound*	Audio connector 3.5 mm MIC IN / headphone OUT / CTIA-Standard
*factory assembled on request #ODM option	

Tab. 1: Options



## Accessories

For accessories please contact our sales department.

Accessories	Description
4-pin power cable	Power cable with open ends
Power supply (90 W / 24 V)	Power supply incl. cable with EU plug
Display cable	Cable MiniDP to HDMI, 2 m, with interlock
WLAN/BT antenna	SMA antenna
LTE/GPS antenna	SMA antenna with or without cable
DIN rail clip	DIN rail clip with screws for „TS35“ hat-rails

Tab. 2: Accessories

## System Features and Intended Use

The BoxPC is the perfect industrial grade communicator for secure and reliable IoT communication. Many interfaces provide a wide range of applications. The simultaneous use of 4G(ODM only) and WLAN(ODM only) allows extended router applications.

The BoxPC is intended for indoor use only.

## Scope of Delivery

Before you begin installation, please check that your shipment is complete and contains the items listed on the delivery note.

## Type Label

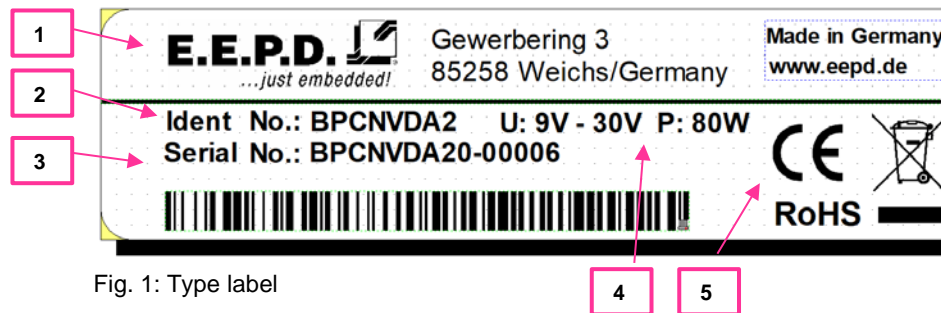

Fig. 1: Type label

- 1 – Manufacturer
- 2 – Product name
- 3 – Serial number with barcode
- 4 – Technical data
- 5 – Certification information

## System Mounting

For use as a desktop computer, apply the self-adhesive rubber feet to the bottom of the housing.



Before attaching the rubber feet, please clean / degrease the bonding areas with a suitable solvent, e.g. alcohol.

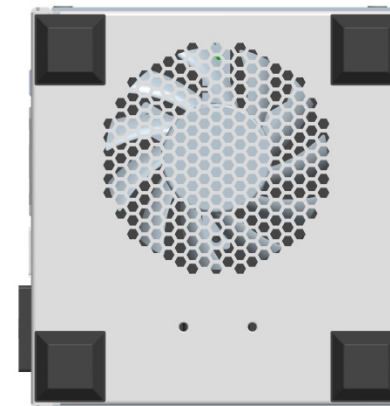

Fig. 2: BoxPC-NUCV with rubber feet

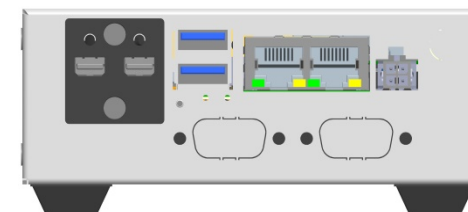

Fig. 3: Front View with rubber feet

System Dimensions

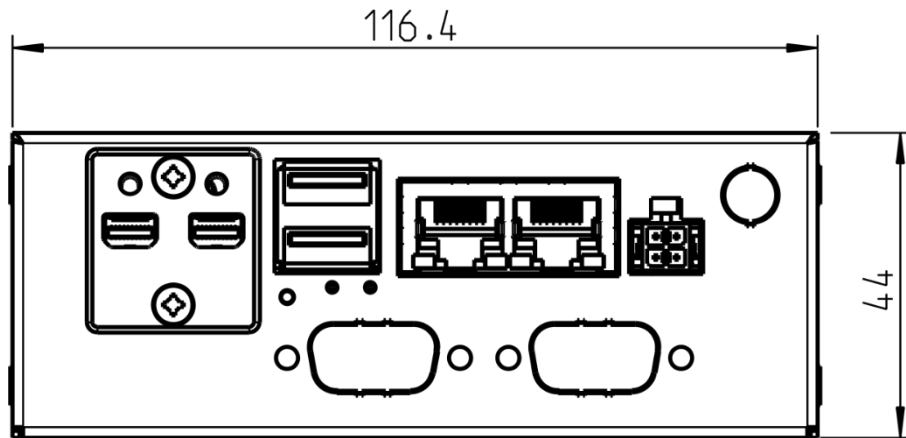

Fig. 4: Dimensions frontside, all values approx. in mm

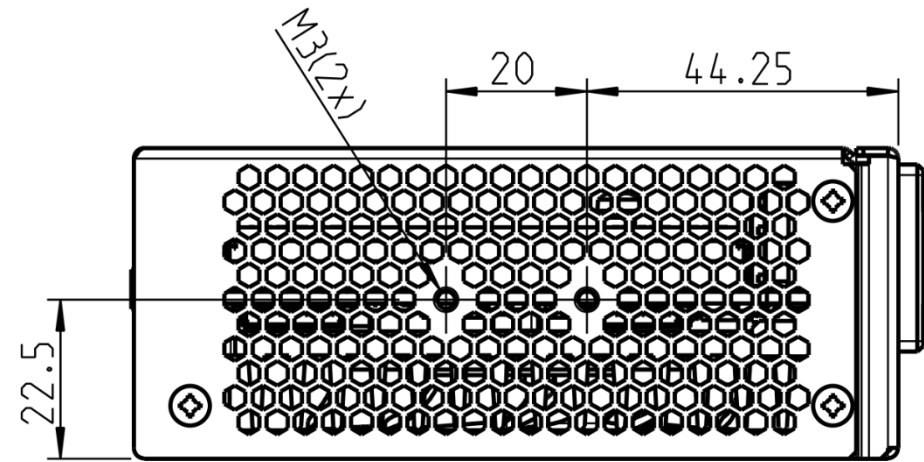

Fig. 6: Dimensions left side, all values approx. in mm

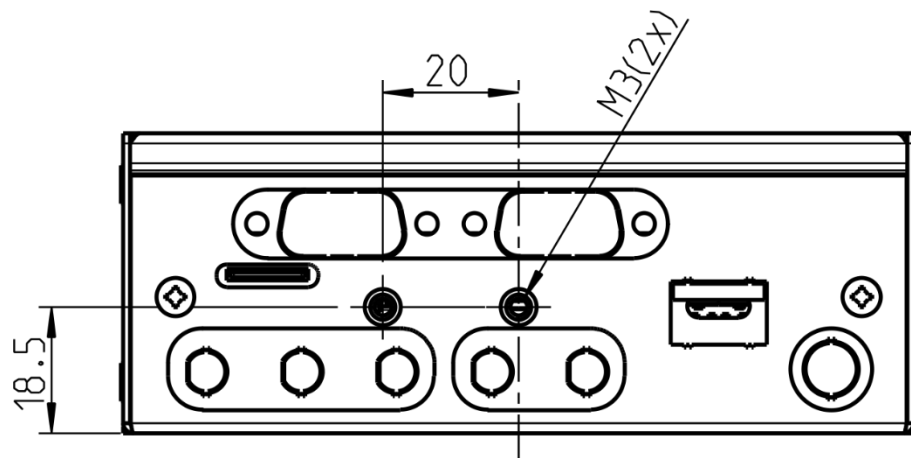

Fig. 5: Dimensions backside, all values approx.. in mm

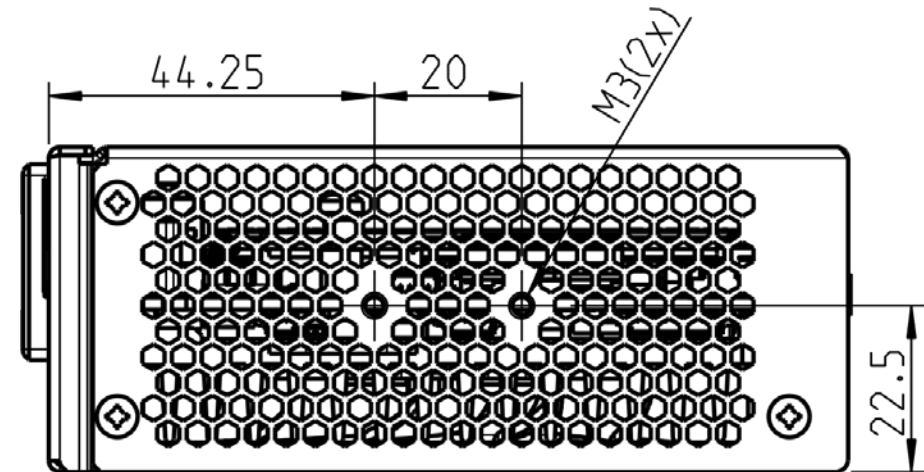

Fig. 7: Dimensions right side, all values approx. in mm

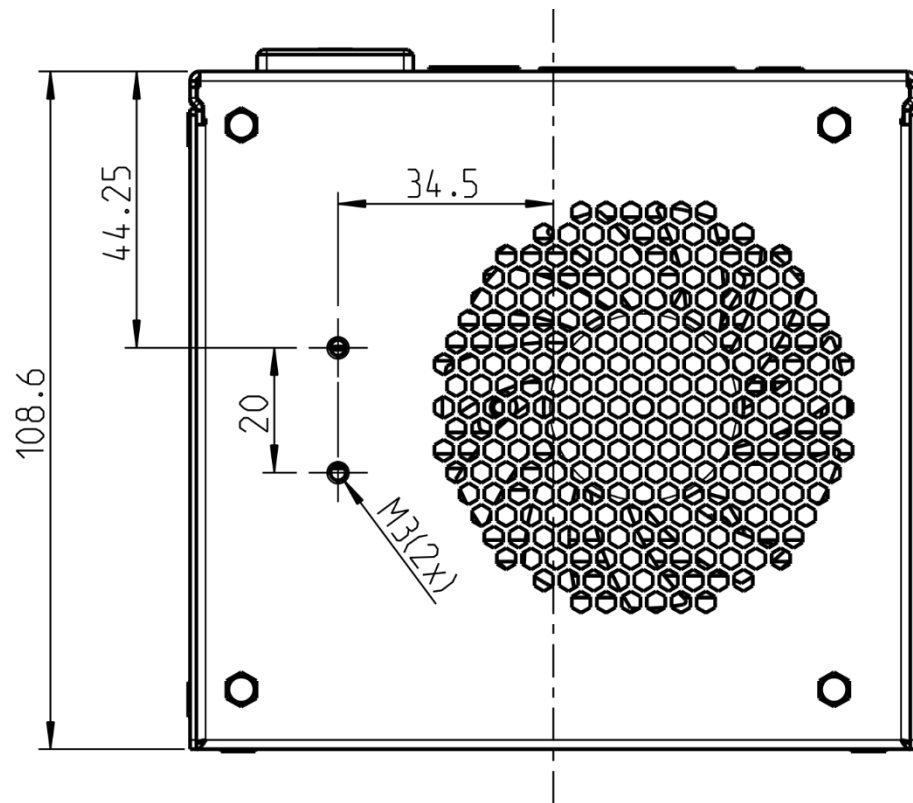
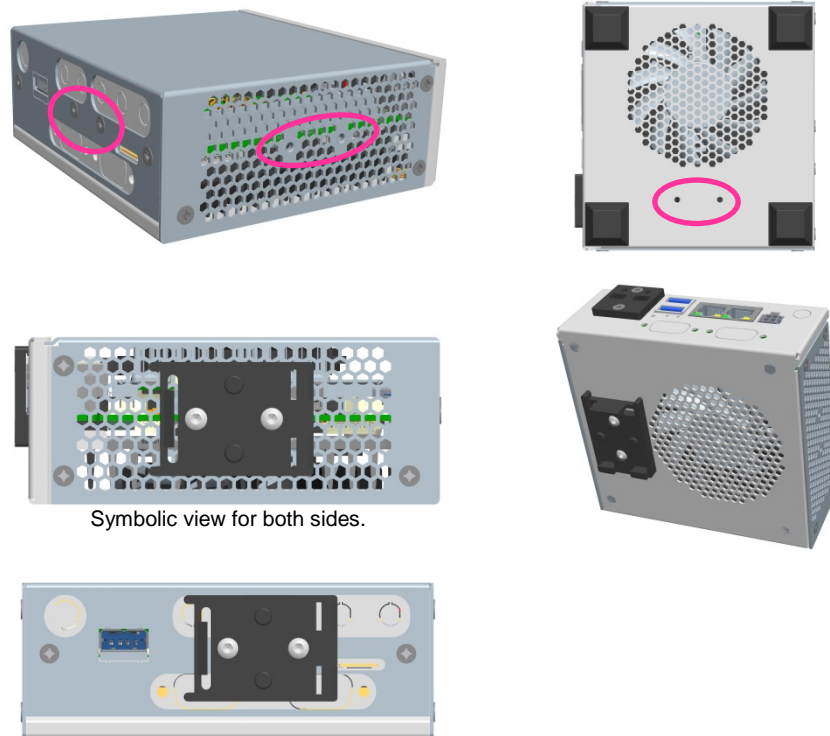

Fig. 8: Dimensions bottom side, all values approx. in mm

## DIN Rail Mounting (optional)

The BoxPC is also designed for DIN rail mounting. There are drilled holes for mounting the optional DIN rail holder in various positions (Fig.9).



Symbolic view for both sides.

Fig. 9: DIN rail holder positions

Please follow the instructions below:

- Mount the top-hat rail holder with two screws M3x6mm at the intended fastening points (see Fig.9+10). The top-hat rail holder is suitable for “TS35” DIN rails.
- Place the system on the DIN rail. Swivel it inwards until it snaps securely into place.
- To detach the system, push it from bottom to top. Swivel it outwards and remove it.

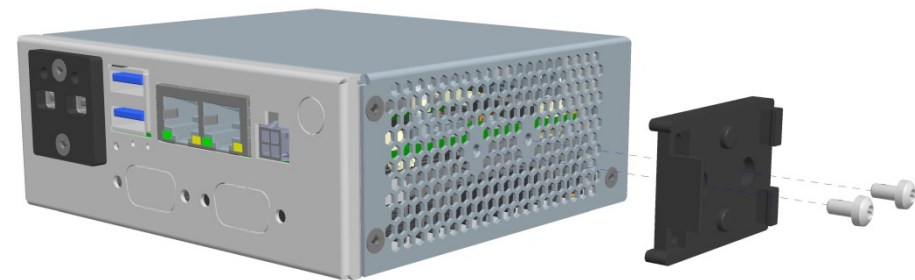

Fig. 10: DIN rail holder mounting

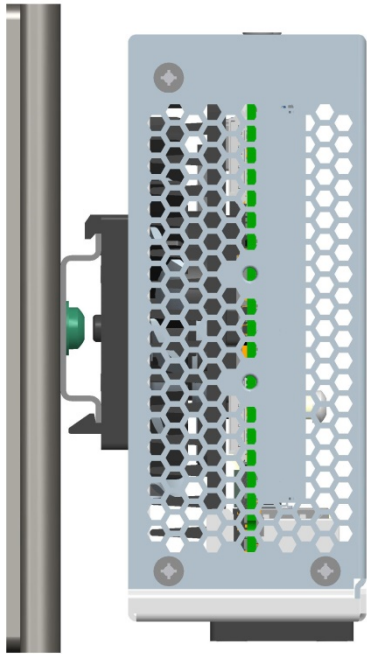

Fig. 11: Side View DIN rail mounted system

## Technical Data

- AMD V1000 processor series:
  - V1202B / 2C / 4T / 2.3 GHz – 3.2 GHz / 12 – 25 W (ODM option only)
  - V1605B / 4C / 8T / 2.0 GHz – 3.6 GHz / 12 – 25 W
  - V1756B / 4C / 8T / 3.25 GHz – 3.6 GHz / 35 – 54 W (max.35W TDP supported by design | ODM option only)
  - V1807B / 4C / 8T / 3.35 GHz – 3.8 GHz / 35 – 54 W (max.35W TDP supported by design)
  - V1404B / 4C / 8T / 2.8 GHz – 3.6 GHz / 12 – 25 W, extended Temp -40 - +85°C
- AMD R1000 processor series
  - R1102G / 2C / 2T / 1.2 GHz – 2.6 GHz / 6 W
  - R1305G / 2C / 4T / 1.5 GHz – 2.8 GHz / 8 - 10 W
  - R1505G / 2C / 4T / 2.4 GHz – 3.3 GHz / 12 – 25 W
  - R1606G / 2C / 4T / 2.6 GHz – 3.5 GHz / 12 – 25 W
- Memory V1000 processor series: max. 32 GB dual-channel DDR4
- Memory R1000 processor series: max. 32 GB dual-channel DDR4
- Memory R1102G processor: max. 16GB single-channel
- Ethernet: 2 Intel® i210 with IEEE1588
- LTE/4G (ODM option): 300 Mbps max. / EMEA, APAC / Diversity / GNSS
- WiFi/BT (ODM option): 802.11 AC with diversity / Bluetooth version 5
- SSD (optional): M.2 SATA or NVME / 64 – 512 GB
- SD card: with MicroSD slot, not bootable
- USB ports: 3 USB 3.1 Gen1
- Serial ports (optional): 1 RS-232 / 1 RS-232/485(FDX only)
- 2 Mini-DP++ connectors up to 4096 x 2160 @ 60 Hz
- Sound (optional): 3.5 mm MIC In / headphone Out
- Controlled FAN (PWM + Tacho), hardware monitoring and watchdog
- Power and Status LED
- Power supply: Min. 8 V / Max. 32 V (DC)  
Suitable for direct connection to vehicle board networks (12 V / 24 V)
- Operating temperature: 0 °C to +60 °C ambient commercial grade
  - Operating temperature of BoxPC-NUCVD|NUCVG with V1807B processor: 0 °C to +50 °C
  - Operating temperature of BoxPC-NUCH with V1404B processor: -40 °C to +85 °C ambient industrial grade
- Storage temperature: -40 °C to +85 °C
- Relative humidity: 95 % @ 40 °C, non-condensing
- Housing: sturdy metal case
- Mounting: stand alone or top-hat rail
- Dimensions approx: 117 x 44 x 113 mm
- Weight: approx. 700g
- Conformity: CE, ROHS, REACH

## Interfaces

### Connection Overview

The BoxPC is equipped with the following standard interfaces:

- 1 – 2x Mini-DP++ connector
- 2 – Dual-USB 3.0 port, type A
- 3 – 2x Ethernet 10/100/1000 Mbit/s (RJ45)
- 4 – Power supply
- 5 – Power button
- 6 – MicroSD card slot
- 7 – USB 3.0 port, type A

Depending on the version, additional interfaces are available. The following table shows the standard systems.

Front View

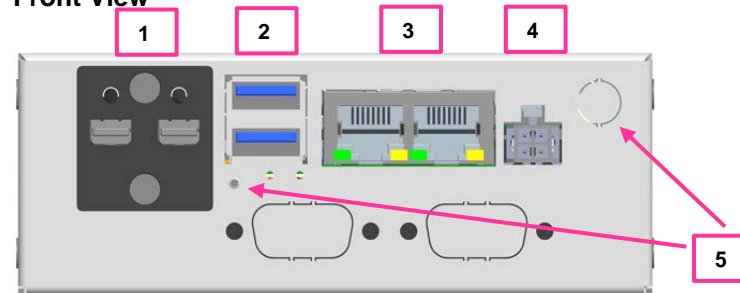

Fig. 12: BoxPC-NUCV Front View

Rear View

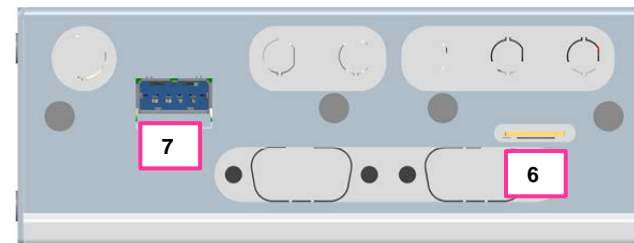

Fig. 13: BoxPC-NUCV Rear View

System ordering code	Description
BPCNVA	V1202C / 2C / 4T / 2.3 GHz – 3.2 GHz / 12 – 25 W
BPCNVB	V1605C / 4C / 8T / 2.0 GHz – 3.6 GHz / 12 – 25 W <sup>#</sup>
BPCNVC	V1756C / 4C / 8T / 3.25 GHz – 3.6 GHz / 35 – 54 W* <sup>#</sup>
BPCNVD	V1807C / 4C / 8T / 3.35 GHz – 3.8 GHz / 35 – 54 W*
BPCNVE	V1404B / 4C / 8T / 2.8 GHz – 3.6 GHz / 12 – 25 W
BPCNRA	R1505G / 2C / 4T / 2.4 GHz – 3.3 GHz / 12 – 25 W
BPCNRB	R1606G / 2C / 4T / 2.6 GHz – 3.5 GHz / 12 – 25 W
BPCNRC	R1102G / 2C / 2T / 1.2 GHz – 2.6 GHz / 6 W
BPCNRD	R1305G / 2C / 4T / 1.5 GHz – 2.8 GHz / 8 - 10 W

\*supports only max. 35W TDP settings | <sup>#</sup> ODM only

Tab. 3: Standard Systems



## MicroSIM Card

In order to insert the MicroSIM card, open the housing.  
Remove the screws on the left, right and rear side (Fig.14). Then you can take off the cover plate.



Fig. 14: Housing Screws

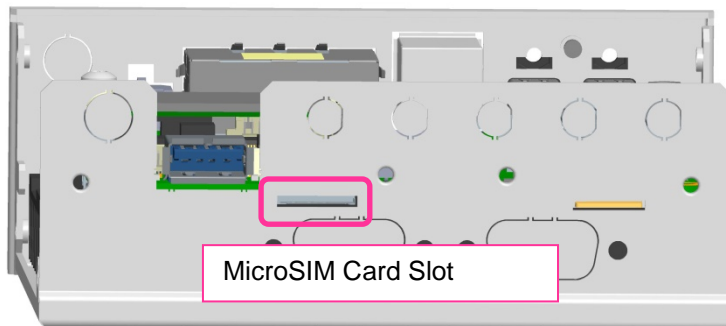

Fig. 15: Open Housing | MicroSIM Card Slot

To lock the card, fully insert it into the slot (Fig.15). Make sure the golden contacts are downwards.

To remove the card, first push it inwards.

## MicroSD Card

It is not necessary to open the case to insert the microSD card. The required slot is located at the rear side of the system (Fig.16).

To lock the card, slide it completely into the slot until you hear a click. To remove it, first push the card inwards.

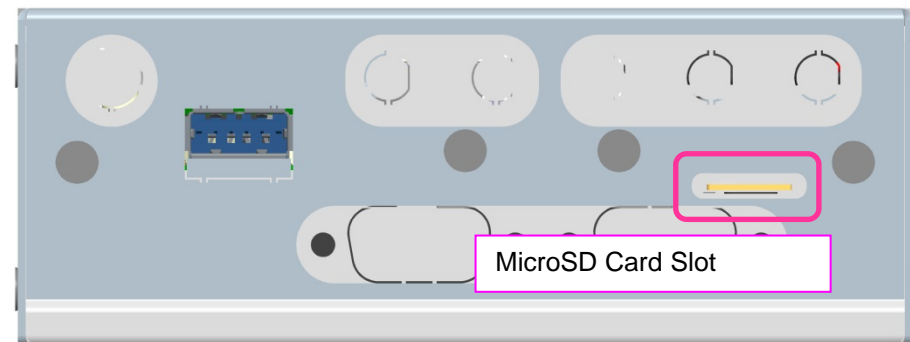

Fig. 16: MicroSD Card Slot

## Power Button | Power and HDD/SSD LED

Press the power button (Fig.17) once to switch on the computer.  
Hold the power button (>4 Sec.) to turn the system off.

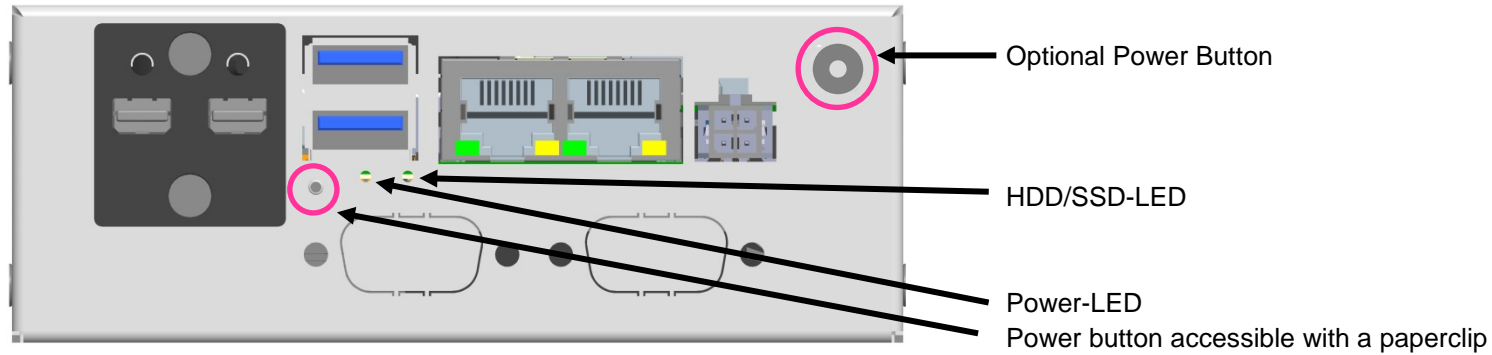

Fig. 17: Power Buttons

## Pin Assignment

### MiniDisplay Ports

Standard pin assignment



Fig. 18: MiniDisplay port detail

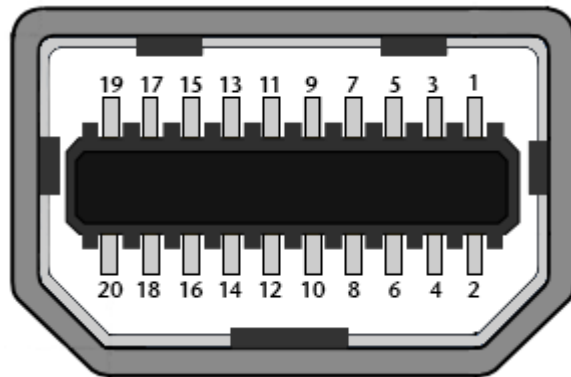

Fig. 19: MiniDisplay port schematic

### Important Note:

There are two kinds of DisplayPort cables available:



Cables for direct connection to a MiniDisplay Port monitor with Pin 20 on both ends of the cable NOT connected.

Cables for use with dongles (e.g. MiniDisplay Port to Display Port, MiniDisplay Port to HDMI) with Pin 20 on both ends of the cable connected.

Possible effects if wrong cable is used:

- System might not start up properly.
- Dongle doesn't work properly (e.g. black display).

### Dual-USB 3.0

Standard pin assignment

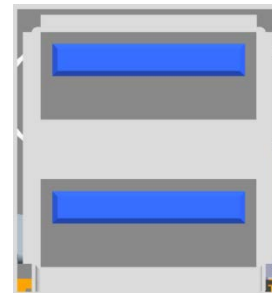

Fig. 20: Dual-USB 3.0 detail

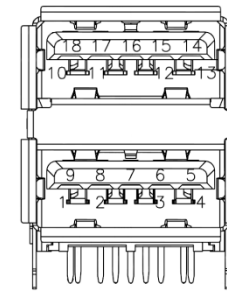

Fig. 21: Dual-USB 3.0 schematic

## Gigabit Ethernet Dual-Port

Standard pin assignment

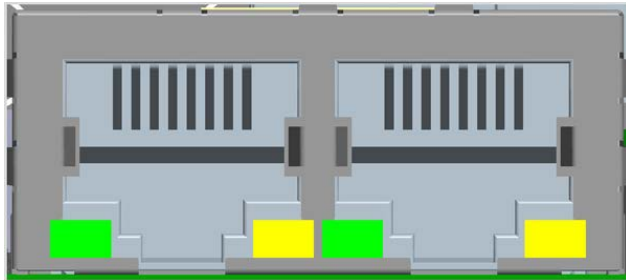

Fig. 22: Dual-Ethernet detail

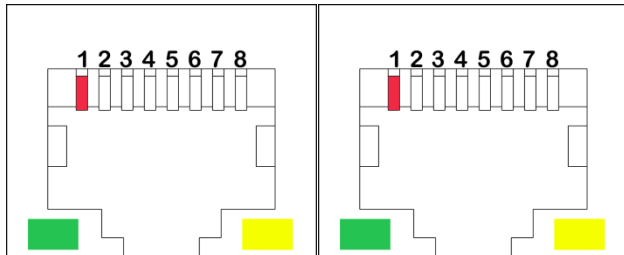

Fig. 23: Dual-Ethernet schematic

### Yellow LED

Speed-LED is on during 1 Gbit transmission and switched off during 10/100 Mbit transmission.

### Green LED

Link-/Activity-LED is permanently on to indicate an active connection on the Ethernet port. LED flashes during communication with the Ethernet network.

E.E.P.D. GmbH | Gewerbering 3 | 85258 Weichs

Copyright © 2020|2021 by E.E.P.D. GmbH. All right reserved. | Rev.3.1

## Power Connector (DC)

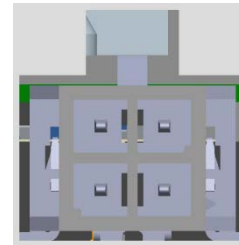

Fig. 24: Power connector detail

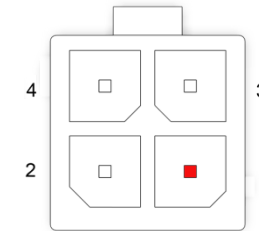

Fig. 25: Power connector schematic



### Counterpart - plug:

Nexus Series 2300, 3.00 mm Micro MF Housing with Lock  
Ordering Number: 2300P04XXX

Pin	Signal	Description
1	GND_IN	Ground
2	GND_IN	Ground
3	PVIN	DC+ (min. 8 V to max. 32 V)
4	KL_15	Ignition

Tab. 4: Pin assignment power connector

### RS232 (optional)

This option must be enabled in the BIOS.

The 9-pin standard D-Sub connector (Fig.26) is connected to four wires.

9-pin D-Sub	Signal
2	RXD1_X
3	TXD1_X
5	GND
7	RTS1_X_m
8	CTS1_X_m

Tab. 5: Pin assignment RS232

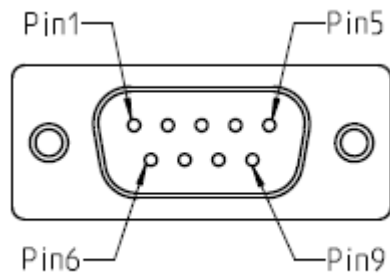

Fig. 26: 9-pin D-SUB connector

### RS232 / RS485 (UART / optional)

This option must be enabled in the BIOS.

The serial RS232/RS485 interface is provided by a multiprotocol transceiver. The RS485 mode is available as a full duplex configuration only. The RS232 mode is connected to four wires. The connector is a standard 9-pin D-Sub connector (Fig. 26).

9-pin D-Sub	Signal RS-232	Signal RS-485 FDX only
1	-	RS485_TX_N
2	RXD0_X	RS485_TX_P
3	TXD0_X	RS485_RX_P
4	-	RS485_RX_N
5	GND	GND
7	RTS0_X_m	-
8	CTS0_X_m	-

Tab. 6: Pin assignment RS232/RS485

## Rear USB 3.0 Port

Standard pin assignment

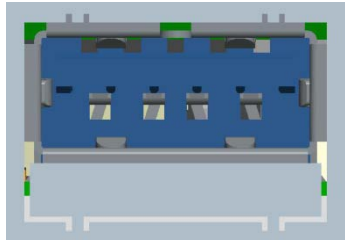

Fig. 27: USB 3.0 detail

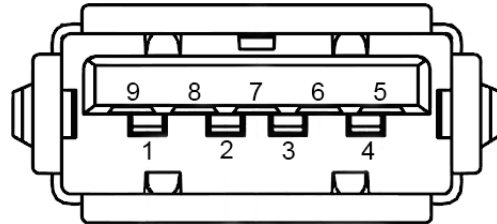

Fig. 28: USB 3.0 schematic

## MicroSD Slot

Standard pin assignment



Fig. 29: MicroSD slot detail

## Commissioning



If connections are no longer accessible after system installation, connect all cables before final mounting. If necessary, also insert the MicroSD card and the MicroSIM card in advance.



Only connect the power cable when the power supply is switched off.



Only insert the MicroSIM card when the system is switched off. Only remove the MicroSIM card when the system is switched off.

Before commissioning, we recommend connecting or inserting:

- Monitor
- USB keyboard and mouse
- Network cable (optional)
- MicroSD card and MicroSIM card (optional)
- DC power supply

Other plug & play devices can be connected after commissioning.

## Switching on the device / Operation

After all preparations have been made, the system is ready to be connected to the power supply.

Press the power button to switch on the system. When the system is powered, the Power LED on the optional power button will be on. When the system boots, the Status LED on the housing lights up to indicate that all internal voltages are at normal levels.

If an operating system is installed, it will start now. An operating system installation can be performed with all common installation media such as USB stick, USB DVD drive or remote network start. The BIOS boot order has to be adjusted accordingly. To enter the BIOS setup, press the "Del" key immediately after switching on.

Please refer to the operating system manual for switching off / shutting down.

## Revision History

Date	Version	Changes
14.10.2019	1.0	First release
22.10.2019	1.1	Minor text improvements
06.11.2019	1.2	Final corrections
05.12.2019	1.3	Chapter „System Dimensions“ added
05.03.2020	2.0	First public release   NUCR added
10.03.2021	3.1	Different operating temp. for V1807 processor added; Design Update; Disclaimer Update



## Index of Figures

Fig. 1: Type label .....	9
Fig. 2: BoxPC-NUCV with rubber feet .....	9
Fig. 3: Front View with rubber feet.....	9
Fig. 4: Dimensions frontside, all values approx. in mm .....	10
Fig. 5: Dimensions backside, all values approx.. in mm.....	10
Fig. 6: Dimensions left side, all values approx. in mm .....	10
Fig. 7: Dimensions right side, all values approx. in mm .....	10
Fig. 8: Dimensions bottom side, all values approx. in mm .....	11
Fig. 9: DIN rail holder positions .....	12
Fig. 10: DIN rail holder mounting.....	12
Fig. 11: Side View DIN rail mounted system .....	13
Fig. 12: BoxPC-NUCV Front View.....	15
Fig. 13: BoxPC-NUCV Rear View .....	15
Fig. 14: Housing Screws.....	16
Fig. 15: Open Housing   MicroSIM Card Slot .....	16
Fig. 16: MicroSD Card Slot.....	16
Fig. 17: Power Buttons .....	17
Fig. 18: MiniDisplay port detail .....	18
Fig. 19: MiniDisplay port schematic.....	18
Fig. 20: Dual-USB 3.0 detail .....	18
Fig. 21: Dual-USB 3.0 schematic .....	18
Fig. 22: Dual-Ethernet detail.....	19
Fig. 23: Dual-Ethernet schematic .....	19
Fig. 24: Power connector detail .....	19
Fig. 25: Power connector schematic .....	19
Fig. 26: 9-pin D-SUB connector.....	20
Fig. 27: USB 3.0 detail.....	21
Fig. 28: USB 3.0 schematic .....	21
Fig. 29: MicroSD slot detail.....	21

## Index of Tables

Tab. 1: Options .....	7
Tab. 2: Accessories .....	8
Tab. 3: Standard Systems .....	15
Tab. 4: Pin assignment power connector .....	19
Tab. 5: Pin assignment RS232 .....	20
Tab. 6: Pin assignment RS232/RS485.....	20

## List of Abbreviations

AC	Alternating current
APAC	Asia Pacific and countries
BIOS	Basic input/output system
BT	Bluetooth
DC	Direct current
DDR4	Fourth generation „double data rate“ memory technology
DP	Display port
EMEA	Europe, Middle East, Africa
GND	Ground
GNSS	Global Navigation Satellite System
IoT	Internet of Things
LTE	Long Term Evolution
MIC	Microphone
M.2	Next generation mSATA
NVME	Non-Volatile Memory Express
PWM	Pulse-width modulation
RAM	Random access memory
RS-232	Serial standard interface
RS-485	Serial standard interface
SD	Secure digital memory card
SIM	Subscriber identity module
SMA	Subminiature version A connector
SODIMM	Small outline dual inline memory module
SSD	Solid state drive
UART	Universal Asynchronous Receiver / Transmitter
USB	Universal serial bus
WLAN	Wireless local area network



Your Notes

**E.E.P.D.**  <sup>®</sup>  
*...just embedded!*

**EM** TRUST  
systems you can trust